

# CT-7000 S3

*digital circuit breaker analyzer*



**Vanguard Instruments Company, Inc.**  
[www.vanguard-instruments.com](http://www.vanguard-instruments.com)



# CT-7000 S3

## digital circuit breaker analyzer

The CT-7000 S3 is Vanguard's fourth generation EHV circuit breaker analyzer. The CT-7000 S3 is available with 3 (part number 9021-UC) or 6 contact timing channels (part number 9100-UC). The CT-7000 S3 can fully analyze a circuit breaker's performance by measuring the main contact and resistor contact time, stroke, velocity, over-travel, bounce back and contact wipes. Both contact and motion analysis can be performed on all circuit breaker operations (OPEN, CLOSE, OPEN-CLOSE, CLOSE-OPEN, and OPEN-CLOSE-OPEN). The CT-7000 S3's timing window is selectable between 1 second, 10 seconds, and 20 seconds.

1

### Contact Timing Input Channels

The CT-7000 S3's dry contact timing channels (up to 6 channels) are used to time the circuit breaker main contacts. Each main contact timing channel is capable of detecting the main contact and insertion resistor contact time. Timing results are displayed in milliseconds and cycles.

2

### Breaker Stroke and Velocity

Three dedicated digital travel transducer channels are available on the CT-7000 S3 for measuring circuit-breaker contact stroke, velocity, over-travel, and bounce back. With the use of the Vanguard digital travel transducers, neither calibration nor setting is required. Circuit breaker contact velocity is calculated based on contact's travel distance over a period of time. Special formulas to calculate velocity is also accommodated by the CT-7000 S3. Special feature is also available to "Slow-Close" test the circuit breaker and obtain a test result report.

3

### Resistor Type Transducer Inputs

The CT-7000 S3 offers 3 resistor type transducer input channels. These input channels are used to interface with any resistor-type transducers to monitor the circuit breaker motion. Transducer resistance ranges from 200 Ohms to 10K Ohms.

4

### Voltage Monitoring Channels

The CT-7000 S3 features three voltage monitoring input channels (V1, V2, and V3). The V1 voltage channel is dedicated to monitoring the sub-station DC supply or coil voltage (0-255 V, DC or peak AC). The nominal and minimum DC supply voltage levels are recorded and printed on the tabulated report. An analog waveform showing the DC power supply is plotted on the graphical report. The two digital voltage input channels, V2 and V3, are dedicated to monitoring voltage on/off status presence or absence of the circuit breaker auxiliary switches. Digital waveforms showing V2 and V3 activity are plotted on the graphical report. Three timing events of the V2 and V3 activities are recorded and printed on the tabulated report.

5

### Breaker Initiate Features

A built-in solid-state initiate device is used to operate a breaker from the CT-7000 S3. Operational modes include OPEN, CLOSE, OPEN-CLOSE, CLOSE-OPEN, and OPEN-CLOSE-OPEN. Multiple operation like OPEN-CLOSE, CLOSE-OPEN, and OPEN-CLOSE-OPEN can be initiated by using a programmable delay time (in milliseconds) or by sensing a specific breaker contact condition.

### OPEN/CLOSE Coil Current Monitoring

One built-in, hall-effect sensor records the OPEN/CLOSE coil current amplitude and waveform. The circuit breaker's coil current waveform, effectively, a coil performance "fingerprint" or "current profile", can be used as a diagnostic tool for analyzing the circuit breaker's performance.

6

### Computer Interface

The CT-7000 S3 can be computer-controlled via the USB or optional Bluetooth interface. Windows-based Circuit Breaker Analysis Software is provided with each unit. Using this software, circuit breakers can be timed from the PC. Test records can be retrieved from the CT-7000 S3 and then stored on the PC for future analysis and report generation. Circuit breaker test plans can also be created on the PC and transferred to the CT-7000 S3. Additionally, test records can be automatically exported in Excel, PDF, and XML formats.

7

### Built-in Thermal Printer

The CT-7000 S3's built-in 4.5" wide thermal printer can print the breaker contact analysis results in both tabular and graphic formats.

## ordering information

Part number **9021-UC** CT-7000 S3 with 3 contact channels, cables, and PC software  
 Part number **9100-UC** CT-7000 S3 with 6 contact channels, cables, and PC software  
 Part number **9021-SC** CT-7000 S3 shipping case  
 Part number **TP4-CS** TP4 thermal printer paper (24 rolls)

Part number **9021-DG** CT-7000 S3 Dual Ground Option  
 Part number **9021-OT** CT-7000 S3 Online Timing Option  
 Part number **9021-BT** CT-7000 S3 Bluetooth Option

# CT-7000 S3 Controls & Indicators

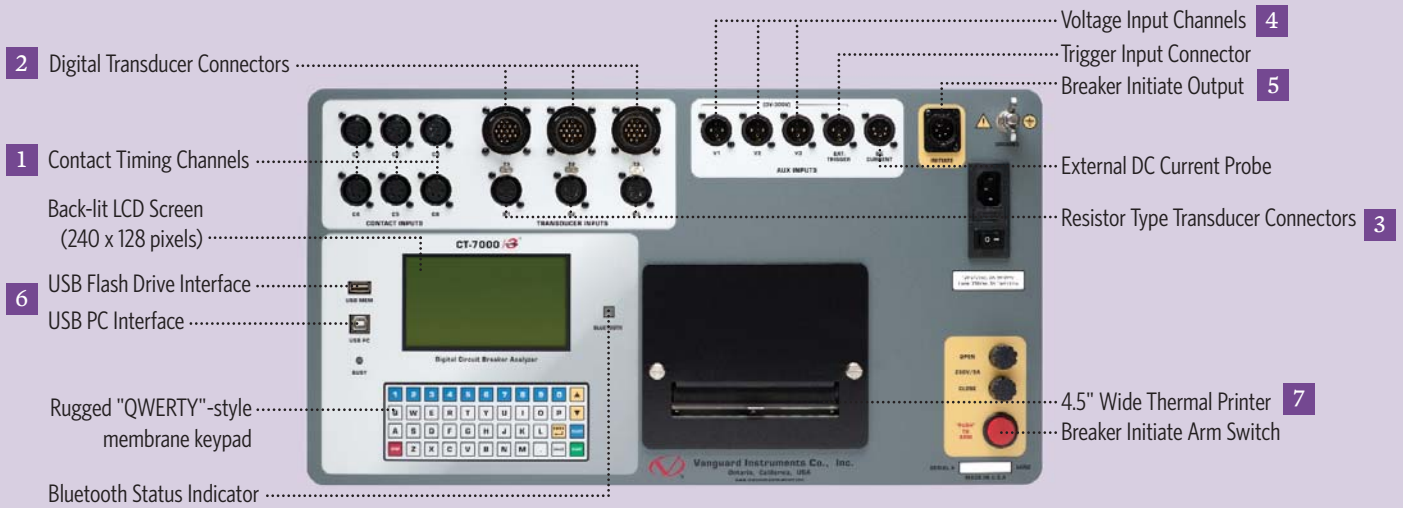

## User Interface

The CT-7000 S3 features a back-lit graphic LCD screen (240 x 128 pixels) that is viewable in direct sunlight and low-light levels. A rugged 44-key "QWERTY"-style membrane keypad is used to control the unit and input information.

## Diagnostic Capabilities

The CT-7000 S3 can perform diagnostics on its internal electronics. Diagnostics can be performed to verify contact cable connections and to test the travel transducer's electronics.

## Internal Test Record and Test Plan Storage

The CT-7000 S3 uses Flash memory to store up to 200 test records internally. Test records can be recalled and printed on the unit's built-in 4.5" wide thermal printer. Test records can also be transferred to a USB Flash drive or exported to a PC via the USB port or Bluetooth (optional) with the included Windows-based software.

Up to 100 circuit breaker test plans can be stored in the CT-7000 S3's Flash memory. A test plan is comprised of all circuit breaker performance specifications (contact time, stroke, velocity, etc.). When a test plan is used with a timing test, a Pass/Fail report is generated by comparing the actual performance with the specifications in the stored test plan. Test plans can be transferred to the CT-7000 S3 from a USB Flash drive, or from a PC via the USB port or Bluetooth (optional).

## Optional Features

### "On-line" Timing Mode



online timing probes  
part no 9021-OT

In addition to the conventional off-line timing mode, the CT-7000 S3 also offers an optional three-phase "on-line" timing mode. In this mode, the CT-7000 S3 captures the breaker's trip or close time, the trip/close coil current "fingerprint," and the battery supply voltage while the breaker is still in service. The trip/close time is derived from the time of trip, or close coil initiation, to the breaker's bushing current breaker-make as detected by a AC clamp-on current sensing probes. Trip/Close current waveforms are also captured by an external clamp-on DC current probe.

The "on-line" timing mode can detect a breaker's operating conditions with little or no down time. In this mode, the first trip operation time of the breaker is captured. If a breaker has been in service for a long period of time and sitting in close position, the first trip time of the breaker may be slow possibly due to a sticky mechanism. The "on-line" mode is very useful in such cases because traditional breaker timing may not detect this condition since several operations may have occurred before the first timing test is conducted.

### Dual Ground Testing Mode



dual ground probes  
part no 9021-DG  
(3 probes)

With the optional dual ground testing mode, the CT-7000 S3 can measure a CB contact time with ground being applied to both sides of the bushings. The clamp-on probe is connected to one side of the CB safety ground straps, and an AC signal is coupled to this strap. A sensor on the probe will detect a change in the induced AC signal when the CB contact is opened or closed.

### Bluetooth Interface

The optional Bluetooth interface can be used to wirelessly connect the CT-7000 S3 with a PC.

# CT-7000 S3 connections

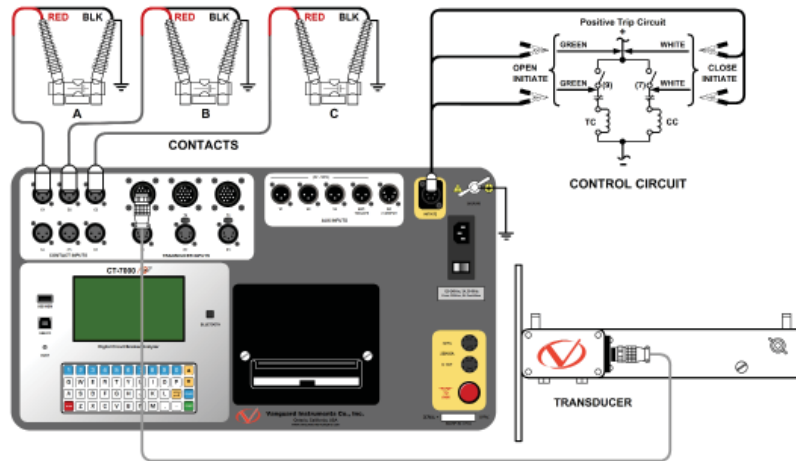

Typical CT-7000 S3 Connections

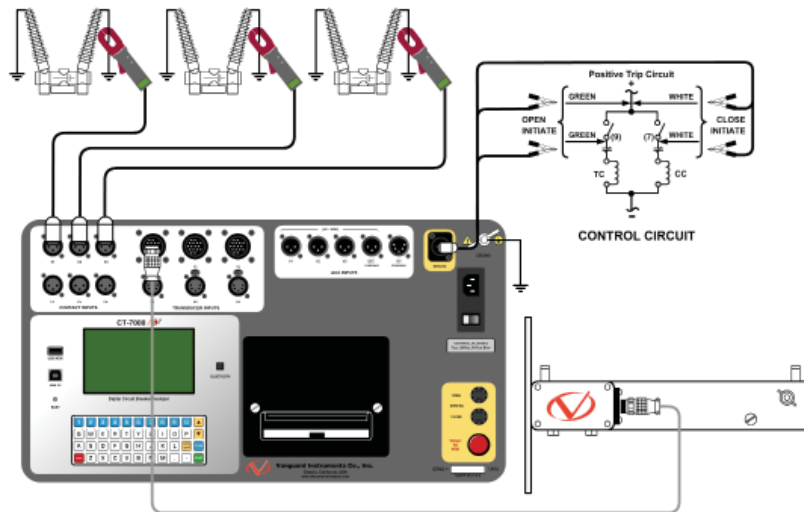

Connections for Optional Dual Ground Testing Mode

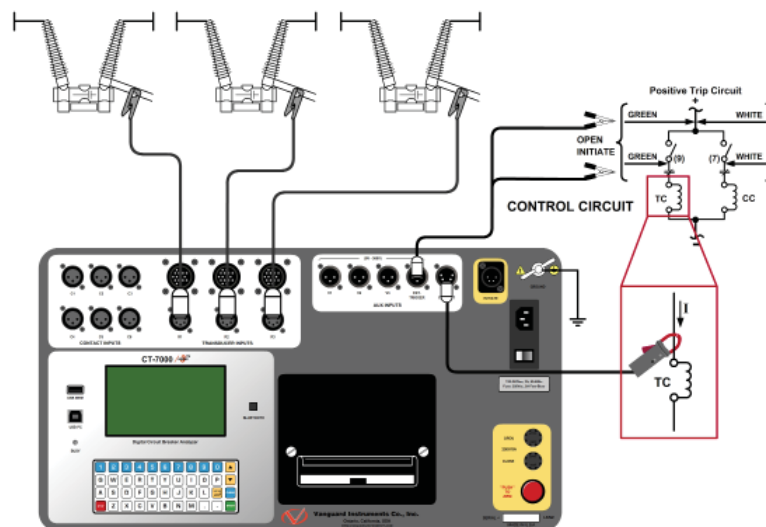

Connections for Optional Online Timing Mode

# CT-7000 S3 specifications

<b>type</b>	Portable Circuit Breaker Analyzer
<b>physical specifications</b>	14"W x 21 1/2" L x 8" D (35 cm x 53 cm x 20 cm); 15 lbs (6.8 Kg)
<b>input power</b>	100-240Vac, 3A, 50/60Hz
<b>dry-contact inputs</b>	3 channels (9021-UC) or 6 channels (9100-UC). Channel can detect the main contact and resistor contact time.
<b>timing windows</b>	1 second, 10 seconds, or 20 seconds
<b>timing resolutions</b>	±50 micro-seconds @ 1 sec. duration, ±500 micro-seconds @ 10 sec. duration, ±1.0 milli-seconds @ 20 sec. duration
<b>timing accuracy</b>	0.05% of reading ±0.05 ms @ 1 second duration
<b>dry-contact channel protection</b>	All contact inputs are grounded until test. Input channels are also protected against static discharge.
<b>dry-contact detection range</b>	Closed: Less than 20 Ohm. Opened: greater than 5000 ohm
<b>insertion resistor detection range</b>	50 – 5,000 ohms
<b>trigger input voltage</b>	Open/Close trigger voltage: 24 V – 300V DC or peak AC
<b>voltage sensing input range</b>	V1: analog input; 0 – 250 V DC or peak AC; sensitivity ±1 V; record and print voltage level V2 and V3: voltage presence/absence detector input; 24 – 255 V DC or peak AC; record and print 3 timing events
<b>breaker operations</b>	Initiate Open, Close, Open-Close, Close-Open, Open-Close-Open
<b>breaker initiate capacity</b>	30A, 250 Vac/dc max
<b>initiate current reading range</b>	one, non-contact, Hall-effect sensor, 0 – 20 amp range, dc to 5 KHz AC
<b>digital travel transducer inputs</b>	3 digital travel transducer channels; linear range: 0.0 – 60.0 in (±0.01 in) rotary range: 0 – 360 degrees (±0.36 degrees)
<b>resistor type transducer input</b>	3 channels, 200 ohm – 10K ohms
<b>contact travel point difference</b>	measures "slow-close" contact-point distances; results can be printed
<b>display</b>	back-lit LCD screen (128 x 240 pixels); viewable in bright sunlight and low light
<b>printer</b>	built-in 4 1/2" wide thermal printer that can print both graphic contact travel waveforms and tabulated test results
<b>internal test record storage</b>	Store up to 200 test records and 100 test plans
<b>external test record storage</b>	USB Flash drive interface for external storage of test records and test plans
<b>computer interfaces</b>	One USB port, optional Bluetooth wireless interface
<b>pc software</b>	Windows® based Breaker Analysis software included with purchase price
<b>cables</b>	furnished with full set of test leads
<b>options</b>	transportation cases (available for the CT-7000 S3 and travel transducers), on-line timing mode, dual ground testing mode, bluetooth interface
<b>safety</b>	designed to meet UL 6101A-1 and CAN/CSA C22.2 No 1010.1-92 standards
<b>environment</b>	Operating: -10°C to +50°C (+15°F to +122°F); Storage: -30°C to +70°C (-22°F to +158°F)
<b>humidity</b>	90% RH @ 40°C (104°F) non-condensing
<b>altitude</b>	2,000 m (6,562 ft) to full safety specifications
<b>warranty</b>	one year on parts and labor

**NOTE :** the above specifications are valid at nominal voltage and ambient temperature of +25°C (+77°F). Specifications are subject to change without notice.

## Optional Testing Features

### ON-LINE TIMING MODE

<b>on-line current sensor</b>	three non-contact AC current sensors, range 0-100 amperes
<b>on-line dc current sensor</b>	one non-contact DC current sensor, range 0-20 amperes

### DUAL GROUND TIMING MODE

<b>dual ground clamp-on probes</b>	3 non-contact clamp-on probes
------------------------------------	-------------------------------

# CT-7000 S3 desktop printer output

## Desktop printout of tabulated test results



### Vanguard Instruments Company, Inc.

Filename:	76072-052908-SHOT069.DAT	Date/Time:	08/30/11 11:36:25
Company:	DUKE ENERGY	Manufacturer:	SIEMENS
Station:	DAN RIVER 100 YARD	S/N:	30075423 4
Circuit:	30075423 4	Operator:	J THOMPSON
Model:	SPS2	Test:	OPEN

#### CONTACT (OPEN)

CHA	P/F	Time(ms)	Cycle	Bounce(ms)	Wipe(mm)
1	P	27.300	1.64	0.05	34.04
2	P	27.500	1.65	0.05	34.93
3	P	27.200	1.63	-0.05	33.53

Delta Time(ms): 0.300 (P/F) = F

CT Channel Analysis: 0.000 (ms)

#### Travel Analysis

	T1	P/F
Stroke (mm)	109.22	P
Velocity (m/s)	5.49	P
Overtravel (mm)	4.19	P
Bounce Back (mm)	2.16	P

#### Speed Analysis

AP1 CT  
AP2 CT+10.000 ms

Initiator Current: 12.136 A

V1 Nominal: 0V

V1 Min: 0V

Shot Length: 1 SEC

Insertion Resistor: None

Delay: None

Trigger: Internal

## Desktop printout of graphic test results

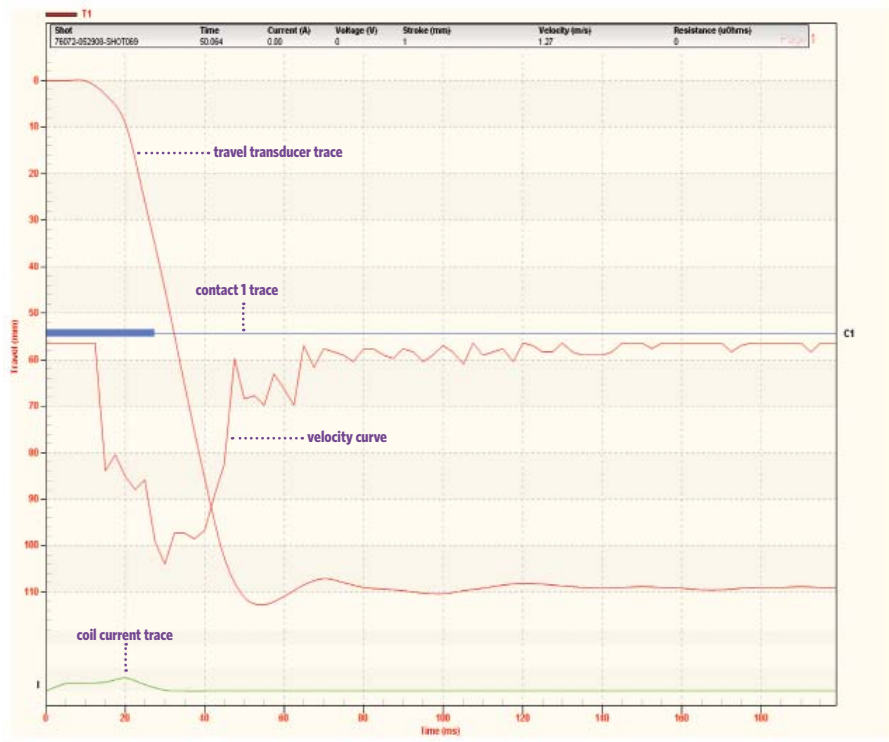

# CT-7000 S3 thermal printer output

## Thermal printout of tabulated test results

BREAKER TIMING RESULTS - 60 Hz				
SHOT NUMBER: 44				
DATE: 07/17/13 TIME: 14:41:02				
COMPANY: VANGUARD INSTRUMENTS				
STATION: STATION NUMBER 1				
CIRCUIT:				
MFR: ABB				
MODEL: 72PM31 12B				
S/N: 101797				
OPERATOR: UI N				
TEST: OPEN				
CONTACT TIME				
CH	TIME	CYCLE	BOUNCE	WIPE
	<ms>		<ms>	<mm>
1	39.95	1.98	0.05	47.80
2	39.15	1.99	0.15	45.80
3	39.50	2.01	0.10	47.90
DELTA TIME <ms>: 0.35				
TRAVEL ANALYSIS T1				
STROKE	mm	120.1		
SPEED	M/S	0.21		
OVER-TRAVEL	mm	1.1		
BOUNCE BACK	mm	0.6		
SPEED ANALYSIS:				
POINT 1	=	30.0 mm		
POINT 2	=	70.1 mm		
U1 NOMINAL VOLTAGE = 0 VOLTS				
U1 MINIMUM VOLTAGE = 0 VOLTS				
U2/U3 TRANSITION TIMES				
	U2		U3	
T1:	35.50 ms		35.30 ms	
T2:	N/A		N/A	
T3:	N/A		N/A	
INITIATOR CURRENT = 9.7 AMPS				
SHOT LENGTH: 1 SECOND				
INSERTION RESISTOR: NO				
TRIGGER: INTERNAL				

## Thermal printout of graphic test results

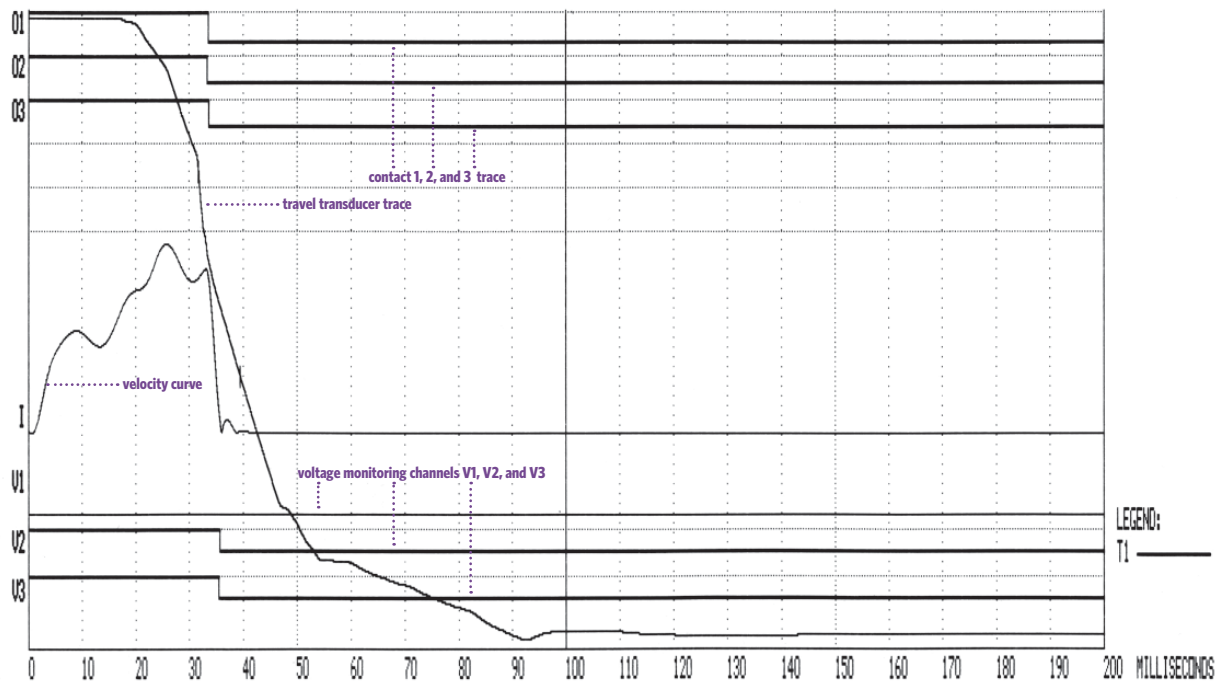

# VCBA S2

## Vanguard circuit breaker analyzer software

The Vanguard Circuit Breaker Analyzer Series 2 (VCBA S2) Windows®-based software is included with all compatible Vanguard Circuit Breaker Analyzers (CT-6500 S2, CT-7000 S2, CT-7500 S2, CT-8000, CT-7000 S3, DigiTMR S2, DigiTMR S2 PC) at no additional cost. This robust application can be used to control the circuit breaker analyzer from a PC to perform CB timing tests. It can also be used to retrieve test records from the circuit breaker analyzer, analyze timing records, and view test results in tabulated and graphical format. Circuit breaker test plans can also be created and transferred to the circuit breaker analyzer.

### Retrieving and Analyzing Test Records

The VCBA S2 software can be used to quickly retrieve test records from a compatible Vanguard circuit breaker analyzer. Test results can be viewed in tabular and graphical format and can be saved on the PC hard drive. Test record header information, such as the company name, station, circuit, operator name, manufacturer, model, and serial number can also be edited.

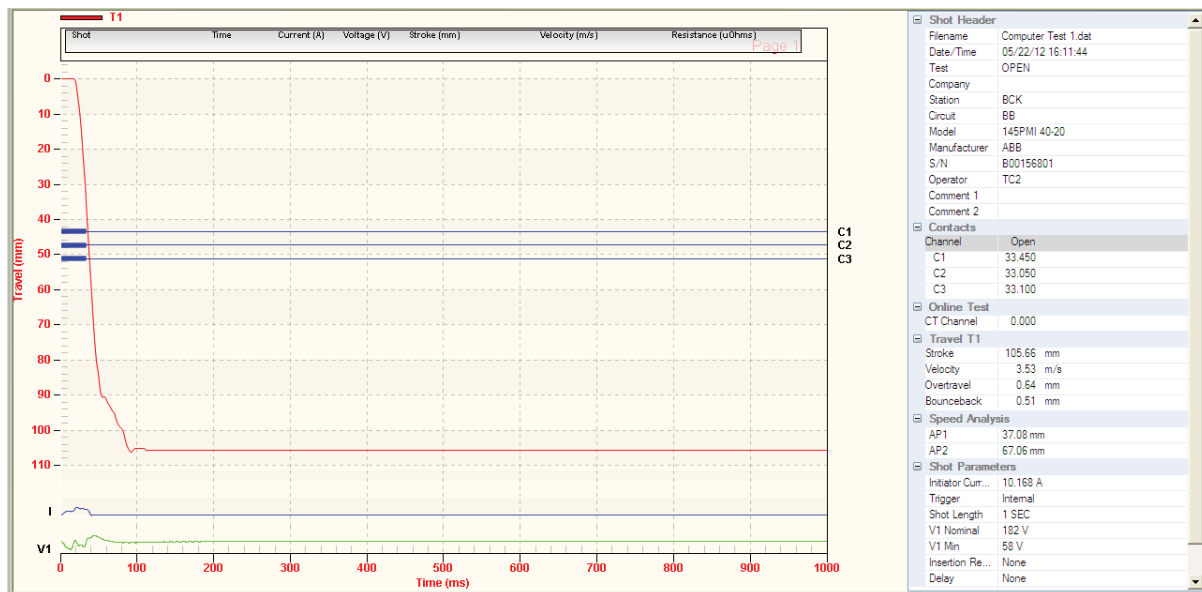

Sample Test Results (OPEN Test)

### Getting a Closer View with Graph Expansions

The VCBA S2 software can be used to expand a portion of the graphical test results for more accurate analysis.

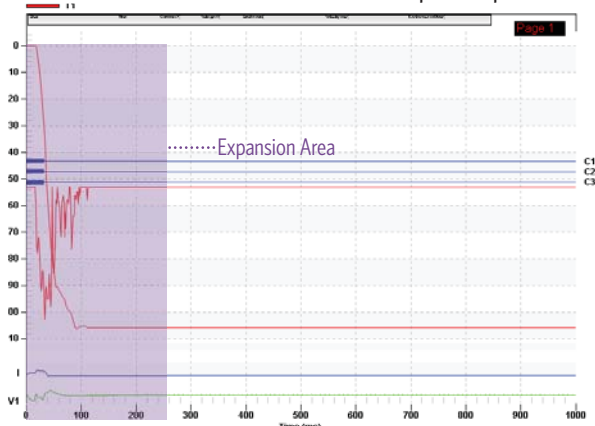

Graphical Test Results

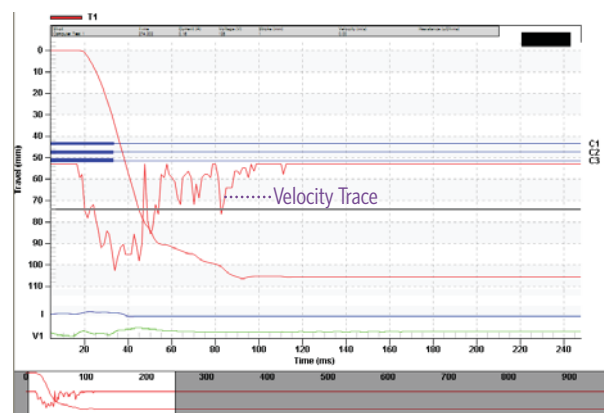

Graphical Test Results Expansion (from 0 to 200ms)

## Timing a Circuit Breaker with the VCBA S2 Software

The VCBA-S2 software can be used to control a CB analyzer and run circuit breaker timing tests. The following tests are supported: OPEN, CLOSE, OPEN-CLOSE, CLOSE-OPEN, OPEN-CLOSE-OPEN, and STATIC RESISTANCE. Also, a test plan for a specific breaker can be used with the test. If a test plan is used, the Pass/Fail indicator will be displayed based on the settings in the test plan.

The screenshot shows the 'Time Breaker' software window. It is divided into several sections:

- File Information:** Test Plan: c:\Vanguard\VCBA-S2\TestPlan\default.set; Save To: C:\Vanguard\VCBA-S2\Shots for Catalog; Filename: Shot. There are checkboxes for 'Add Date' and 'Add '001' to ensure uniqueness'.
- Shot Type:** Radio buttons for 'Open', 'Close', 'Open - Close', 'Close - Open', 'Open - Close - Open', and 'Static Resistance'. A dropdown menu for 'Close - Open' is set to 'Contact #1 Closed'. There are input fields for 'Delay between Open-Close' and 'Delay between Close-Open', both set to 10.
- Timing Window:** Radio buttons for '1 Second', '10 Second', and '20 Second'. '1 Second' is selected.
- Trigger Type:** Radio buttons for 'Internal' and 'External'. 'Internal' is selected.
- Insertion Resistor:** Radio buttons for 'None', '< 1000 ohms', '1000 - 2000 ohms', and '> 2000 ohms'. 'None' is selected. There is a checkbox for 'Dynamic Resistance' which is unchecked.

Buttons at the bottom include 'Resend Shot', 'OK', and 'Cancel'.

Breaker Testing Parameters

## Creating Test Plans for Faster Testing

A circuit breaker test plan is comprised of all circuit-breaker performance specifications (stroke, velocity, and contact time). A test plan can be used to test a circuit breaker. When used with a test record, a Pass/Fail report is generated by comparing the actual performance of the breaker with the specifications in the stored test plan. Test plans can be easily created with the VCBA-S2 software and can be stored on the hard drive or transferred to a CB analyzer.

The screenshot shows the 'Shot Information' and 'Contact Analysis' sections of the software:

- Shot Information:** Fields for Company, Station, Circuit, Manufacturer, Model, Serial Number, Operator, Comment #1, and Comment #2.
- Contact Analysis:** A table of timing parameters in milliseconds (ms):

	Open (ms)	Close (ms)	C-O (LIVE) (ms)	Q-C (DEAD) (ms)
Contact Low:	0.0	0.0	0.0	0.0
Contact High:	0.0	0.0	0.0	0.0
Contact Delta:	0.0	0.0		
Resistor On Low:	0.0	0.0	0.0	0.0
Resistor On High:	0.0	0.0	0.0	0.0
Resistor On Delta:	0.0	0.0		
- Travel Analysis:** Fields for 'Open' and 'Close' stroke, velocity, and overtravel. It also includes 'Open Analysis Point' and 'Close Analysis Point' with dropdown menus for 'Point #1' and 'Point #2' (set to 25% and 50% respectively) and a 'Measure Unit' dropdown set to 'English'. There is a 'Manual Override' dropdown set to 'Disabled' and a checkbox for 'Enable Rotary Encoder' with a value of 0.000 in./deg.

Creating a Test Plan

# BREAKER TIMER ACCESSORIES

## CT-7000 S3/CT-8000 S3 OPTIONS



### ON-LINE TIMING PROBES

for CT-7000 S3 part no  
**9021-OT**

for CT-8000 S3 part no  
**9103-OT**



### DUAL GROUND PROBES (3 probes)

for CT-7000 S3 part no  
**9021-DG**

for CT-8000 S3 part no  
**9103-DG**

## TRANSDUCERS



### LINEAR TRANSDUCERS

10" part no **9087-UC**  
25" part no **9088-UC**

All transducers are compatible with the Vanguard DigiTMR S2, DigiTMR S2 PC, CT-7000 S3, and CT-8000 S3 circuit breaker analyzers.



### ROTARY TRANSDUCER WITH MAGNETIC MOUNT

part no **9091-UC**



### ROTARY TRANSDUCER

part no **9090-UC**



### RESISTOR-TYPE TRANSDUCER

part no **9093-UC**

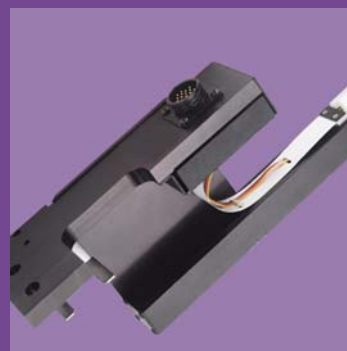

### ABB AHMA-8

mechanism transducer  
part no **9085-UC**



# BREAKER TIMER ACCESSORIES

## TRANSDUCER ADAPTERS



### RESISTOR TRANSDUCER ADAPTER

part no **9095-UC**

The Vanguard Resistor Transducer Adapter (RTA) can be used to connect any resistor type transducer to the digital transducer channel of a Vanguard circuit breaker analyzer. The RTA also features a 3-pin SwitchCraft connector that can directly interface with ABB resistor transducers.



Connected to an ABB AHMB resistor-type transducer



### DOBLE TRANSDUCER ADAPTER

part no **9084-UC**

The Doble Transducer Adapter can be used to interface any Doble travel transducer to a Vanguard circuit breaker analyzer.



Connected to Doble rotary transducer



## Instruments designed and developed by the hearts and minds of utility electricians around the world

Vanguard Instruments Company, (VIC), was founded in 1991. Currently, our 28,000 square-foot facility houses Administration, Design & Engineering, and Manufacturing operations. From its inception, VIC's vision was, and is to develop and manufacture innovative test equipment for use in testing substation EHV circuit breakers and other electrical apparatus.

The first VIC product was a computerized circuitbreaker analyzer, which was a resounding success. It became the forerunner of an entire series of circuitbreaker test equipment. Since its beginning, VIC's product line has expanded to include microcomputer-based, precision micro-ohmmeters, single and three phase transformer winding turns-ratio testers, transformer winding-resistance meters, mega-ohm resistance meters, and a variety of other electrical utility maintenance support products.

VIC's performance-oriented products are well suited for the utility industry. They are rugged, reliable, accurate, user friendly, and most are computer controlled. Computer control, with innovative programming, provides many automated testing functions. VIC's instruments eliminate tedious and time-consuming operations, while providing fast, complex, test-result calculations. Errors are reduced and the need to memorize long sequences of procedural steps is eliminated. Every VIC instrument is competitively priced and is covered by a liberal warranty.



### **Vanguard Instruments Company, Inc.**

1520 S. Hellman Avenue • Ontario, California 91761, USA

Phone 909-923-9390 • Fax 909-923-9391

[www.vanguard-instruments.com](http://www.vanguard-instruments.com)

July 29, 2013